





# TILT & TURN

SERIES 1200





A cousin of our Series 500 Tilt & Turn, the Series 1200 takes an already great window and optimizes it to near perfection. Utilizing state-of-the-art crank handle hardware, the Series 1200 is capable of operating very large windows with ADA-friendly efficiency. This allows for ultra-heavy windows to keep out the noisy street sounds. The 1200 achieves maximal operation due to its high performing hardware system. It also has a modulating operability feature that allows residents to open – and keep open – the window however little or much they want to.



See our website for more details:  
[www.skylinewindows.com](http://www.skylinewindows.com)







SKYLINE  WINDOWS

220 EAST 138TH STREET  
BRONX, NY 10451  
T (212) 491-3000  
F (212) 491-5630

[skylinewindows.com](http://skylinewindows.com)

## FEATURES + OPTIONS

SKYLINE SERIES 1200

CLASS Architectural



MAXIMUM SIZE 8' X 8'  
Maximum sash weight 440 lbs

GLASS 1" - 1 1/4" Insulated Glass  
Structural Silicone Glazing

MULLING Self Stacking; Continuous heads & sills  
1 pc or 3 pc structural

STANDARD STOCK FINISHES  
White Interior / White Exterior  
White Interior / Bronze Exterior  
White Interior / Black Exterior  
Bronze Interior / Bronze Exterior  
AAMA 2603 *Custom Colors &*  
AAMA 2604 *Finishes Available*  
AAMA 2605 *Upon Request*

MUNTINS Internal; I.G.U Muntin; Exterior Replica Muntin

NOTES High Efficiency Thermal & Acoustic Design

## PERFORMANCE AS SPECIFIED

(Based on Independent Laboratory Testing)

AAMA DA-AW-75

STRUCTURAL LOAD 112.5 PSF

AIR @ 6.27 PSF 0.01

WATER 12 PSF

## STANDARD ROTO OPERATOR



## ROTO MAY BE PLACED ON JAMB OR SILL

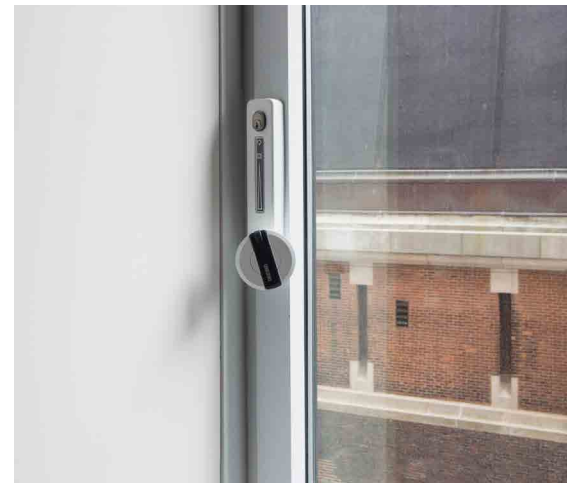

## STANDARD STOCK FINISHES





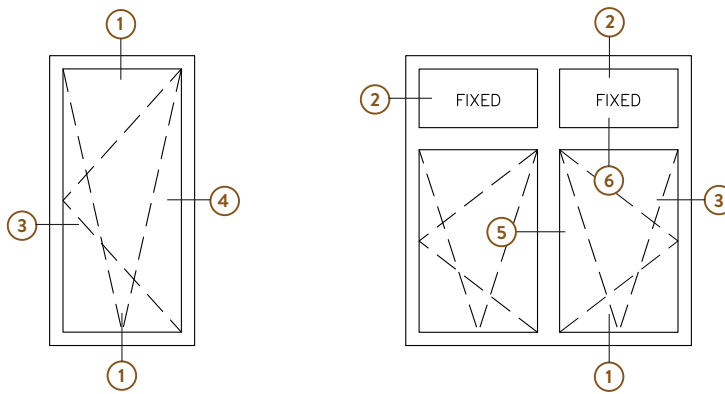

① OPERABLE HEAD/SILL

② FIXED HEAD/SILL/JAMB

③ OPERABLE JAMB W/HINGE

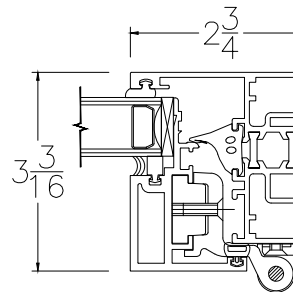
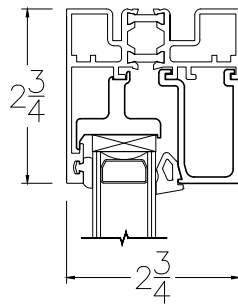
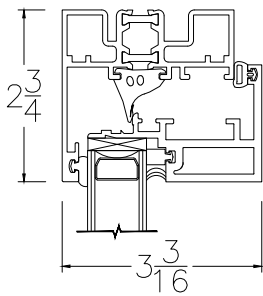

④ OPERABLE JAMB W/CRANK

⑤ OPER/OPER T-BAR

⑥ FIXED/OPERABLE TRANSOM

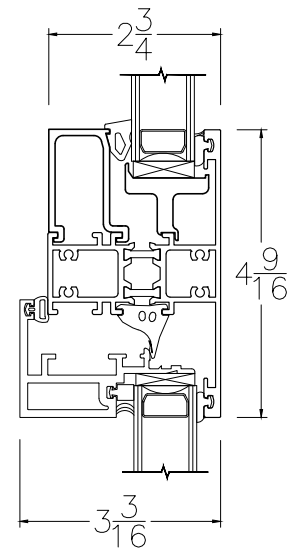
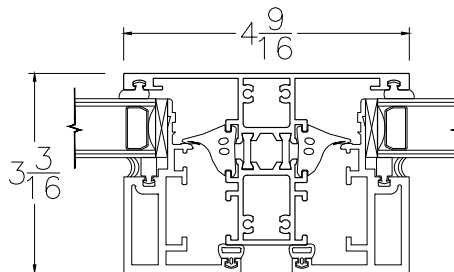
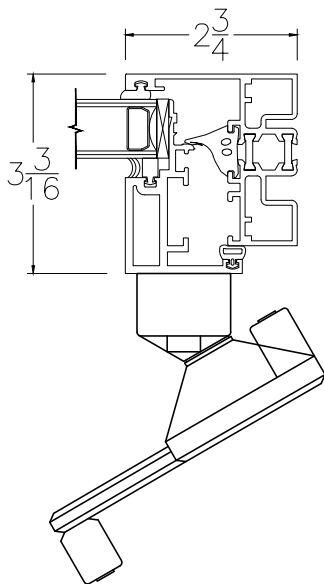

NOT TO SCALE